KITZ

Operation Manual

For
DJ TYPE BUTTERFLY VALVE

(WAFER and LUG TYPE)

Thank you for having chosen KITZ products.

For safe and trouble-free function and performance of the product, make sure to read and understand all items of this manual before valve mounting and operation.

Keep this manual in a convenient place for your valve operators' easy access.

This manual applies to the KITZ manual DJ type butterfly valve of wafer and lug type.

For actuators of automatically operated valve, refer to the operation manual of relevant actuators prepared by the manufacturers.

CAUTION AND WARNING

To ensure safe and trouble-free function and performance of the product, please read all items of this manual before handling, mounting and operation of the units.

The items listed here are indicated to prevent personal injury and product damage.

Please follow the cautions described here.

The signal words "WARNING" and "CAUTION" are defined as follows:



Indicates an imminently hazardous situation which, if not avoided, will result in death or serious injury.



Indicates a potentially hazardous situation which, if not avoided, could result in minor or moderate injury and product damage.



Indicates mandatory implementation of an action.



Indicates prohibition of an action.

NOTES TO USERS

This manual is designed to show an appropriate usage of products for transportation, storage, installation, operation and maintenance.

Be sure to read the manual before starting any of transportation, storage, installation, operation, maintenance, and handling valves. Also be sure to read the operation manual (No. D33 or D33W) enclosed with the product in the package.

This manual does not cover the whole scope of conceivable usage of products for transportation, storage, installation, operation and maintenance. If technical assistance beyond the scope of this manual is required, contact KITZ Corporation or its distributors.

The specifications for transportation, storage, installation, operation and maintenance described in this manual have been determined with valve maintenance taken into consideration. **DO NOT** use products beyond the specifications.

The illustrations given in this manual do not introduce all details. If more detailed data are required, refer to our relevant valve assembly drawings.

Note Any information provided in this operation manual is subject to revision at without prior notice. This edition cancels all previous issues.

C O N T E N T S

	Sheet
Construction and Design Features	1
Valve Operation Device	5
Transportation and Storage of Valves	8
Valve Installation	11
Valve Operation	15
Periodic Inspection	19
Disassembly and Reassembly of valves	23

CHAPTER
Construction and Design Features

Construction and Design Features

DJ Type Butterfly Valves

1. Construction and Function

- 1.1 The valve design and the name of the parts are shown below.
- 1.2 90° rotation of the stem opens and closes the valve.
- 1.3 Butterfly valve is serviceable in fully open, closed and intermediate position for fluid control.
- 1.4 DJ type butterfly valve has center drive mechanism.
- 1.5 The bi-directional flow is available for butterfly valve.

Nominal Size DN50 to DN300
(with vulcanized seat construction)

Nominal Size DN250 to DN300
(with vulcanized seat construction)

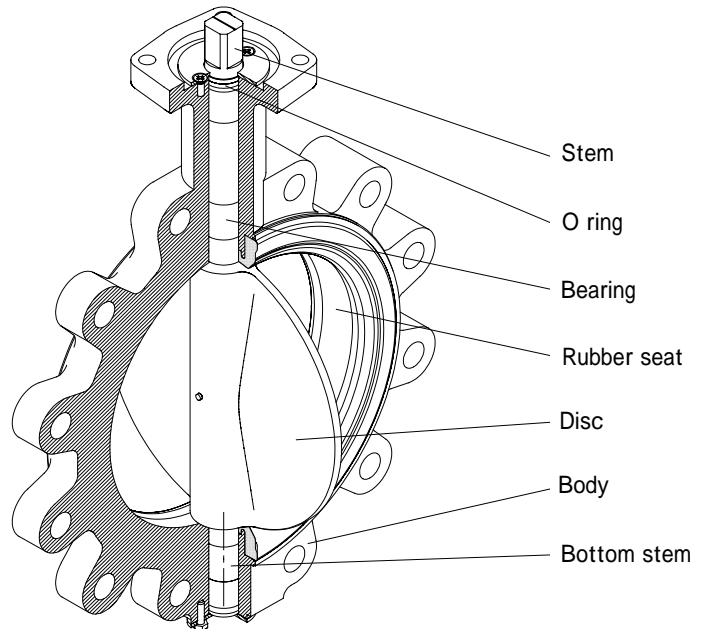
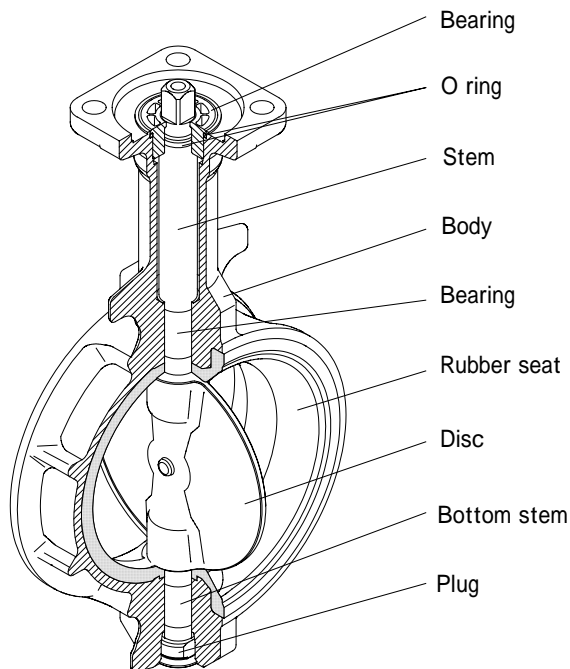

This drawing shows a typical construction of valve.

Construction and Design Features

2. General Feature

- 2.1 Vulcanized seat is applied for the valve with nominal size up to DN 300, and molded seat inserted for DN 350 to DN 600.
The valves with nominal size DN 50 to DN 300 have the vulcanized seat applied and is usable for high flow speed (max. 4m/sec), control and vacuum line without any options due to the construction which the body and rubber seat are integrated into the body. (Note 1)
The valves with nominal size DN 350 & over ensure the performance equivalent to vulcanized seat type by optional specification (adhesion of rubber seat and body). (Note 2)
- 2.2 Face to face dimension should comply with JIS B 2032, ISO 5752, EN 558-1 or MSS SP-67.
- 2.3 Actuator mounting flange should comply with ISO 5211 except outside diameter.
- 2.4 Lower operating torque ensure operability and durability of the valves.
- 2.5 Stem is designed to be blow-out proof.
- 2.6 Double seals are applied at the stem to prevent external leakage.
- 2.7 Both JIS 5K and 10K flanges are usable for the valve, nominal size DN 400 and smaller. JIS 5K with nominal size DN 450 and larger is independent body.
- 2.8 The valve has the longneck design for easier installation of 50mm insulation.

(Note 1) Nominal size DN250 & DN300 may have molded seat inserted type as an option.

(Note 2) Please use our THROTROLL (HRDJ Type butterfly valve) for severe control instead of DJ type butterfly valve.

Construction and Design Features

3. Valve Specification and Pressure-Temperature Rating

3.1 Valve specification

Valves have rubber, so it is limited for the fluids and temperature.

Please ask the justice of availability of fluids to KITZ or piping engineer.

3.2 Pressure-Temperature Rating

P-T Rating for each valve, refer to relevant catalogue.

Although it is available to use below 0 , fluid media should not be frozen.

4. Minimum Inside diameter of Applicable pipes

Never apply the pipes with smaller inside diameter than the figures shown in the following table. That will cause unwanted contact of the valve disc with the pipe ends.

Nominal valve Size			Pipe Inside diameter (mm)
DN	NPS	A	
50	2	50	32
65	2-1/2	65	52
80	3	80	75
100	4	100	92
125	5	125	118
150	6	150	145
200	8	200	195
250	10	250	244
300	12	300	292
350	14	350	332
400	16	400	379
450	18	450	427
500	20	500	473
600	24	600	566

CHAPTER
Valve Operation Device

Valve Operation Device

1. Lever Handle Type

1.1 The lever handle is directly mounted on the valve.

1.2 Turning the lever handle 90° clockwise will close the valve, and turning the lever handle 90° counterclockwise will open the valve.

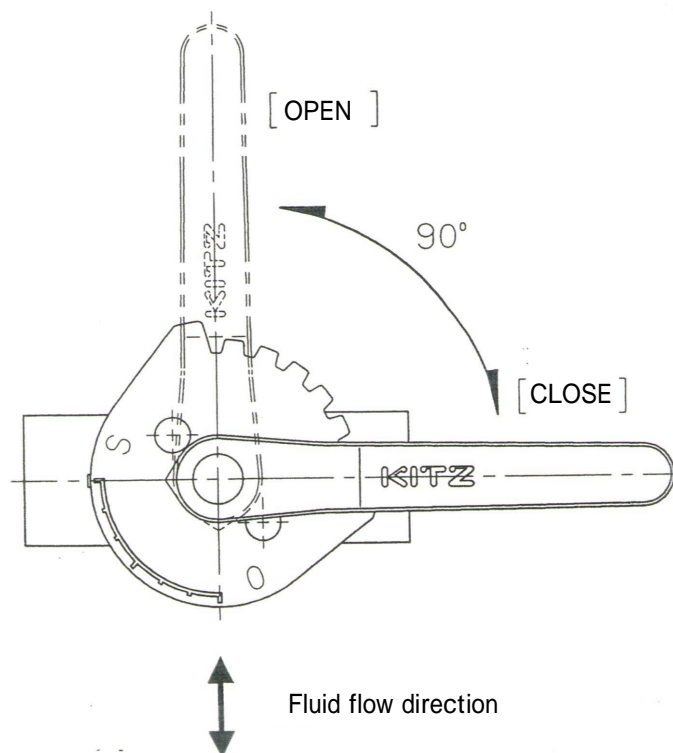

Valve Operation Device

2. Gear Type

- 2.1 The worm gear operation device is mounted on the valve.
- 2.2 According to the letter or arrow on the handwheel, turning the handwheel clockwise will close the valve, and turning the handwheel counterclockwise will open the valve.
- 2.3 Hand wheel operating torque depends on the differential pressure, fluid temperature and opening position.
- 2.4 Gear operator is to transmit a large torque to valve stem, converting a torque from drive shaft by means of reduction gearing unit using worm gears.

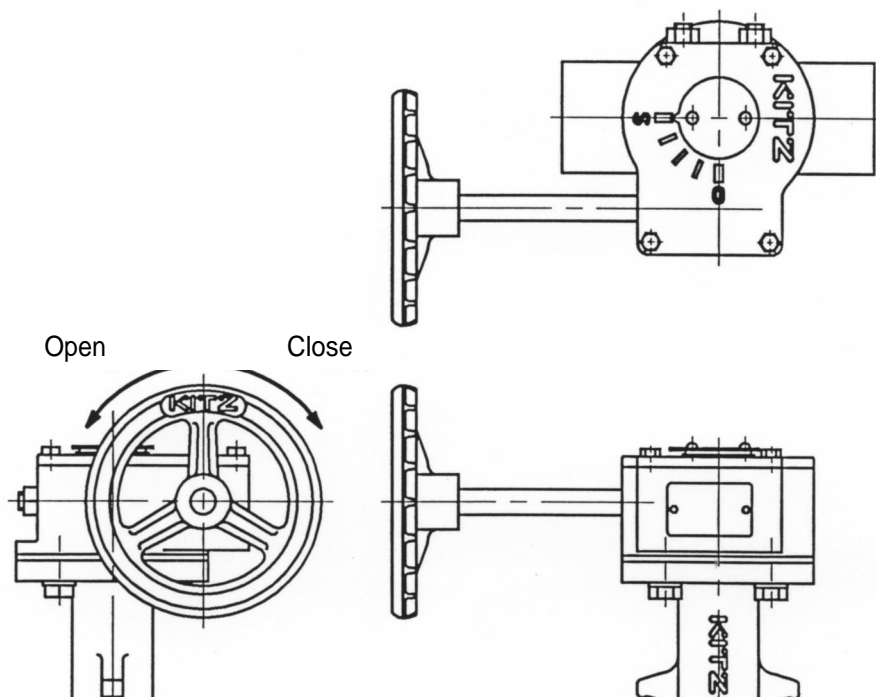





CHAPTER
Transportation and Storage of Valves

Transportation and Storage of Valves

1. Transportation of Valves

1.1 Caution for safety

 WARNING	
	(1) Keep off the valve lifting area to prevent personal injury caused by unsecured valves when transporting the valve by lifting..

 CAUTION	
	(1) Take care not to damage the valve painting surfaces during transportation, which may subsequently cause corrosion and get the valve rusty. Touch-up the damaged surfaces adequately. (2) Take care the handling and storage of the carton packed product. The high humidity may damage the cartons. (3) Be careful not to apply abnormal force to shaft of manual gear. Deformed shaft causes gear and/or valve failures.

1.2 Transportation



1.2.1 Keep the packages as they are delivered just before installation.

1.2.2 Handle valves carefully so that they should not fall or drop on the ground. Avoid any extraordinary mechanical impact.

Transportation and Storage of Valves

2. Storage

2.1 Caution for safety.

 CAUTION	
	<p>(1) DO NOT store valves in the corrosive environment, which may cause corrosion on threaded portions of valves.</p> <p>(2) DO NOT remove protection covers until installation. They prevent any foreign objects from intruding valves.</p> <p>(3) DO NOT place any objects on valves, and DO NOT step on them. Overloading may cause damage to valves.</p> <p>(4) DO NOT pile up products carelessly to avoid damage to products and personal injury caused by unstable piling.</p>
	<p>(5) Keep the valve in the little open position, during storage. Storing the valves in fully closed position may deform the rubber seat, leading to cause of the seat leakage.</p>

2.2 Storage

2.2.1 Indoor storage of valves in a dust-free, low humidity and well-ventilated place is recommended.

2.2.2 DO NOT place the valves directly on the ground or concrete floor.
Place packed valves on the pallets or racks for storage.



2.2.3 In case the valve is stored for a long period of time, keep the valve open by 10° for the protection of the rubber seat from deformation.



2.2.4 Take some appropriate measures to protect valves from direct exposure to dust, rain or sunlight if they are temporarily stored outdoors.

CHAPTER
Valve Installation

Valve Installation

1. Care for Valve Installation



 WARNING	
	<p>(1) Check the valve specifications with the catalogs and/or attached nameplate. The valve stem and rubber seat materials determine the characteristic of service fluid and service range of pressure and temperature. Services beyond the valve specifications will cause the leakage problem or other accidents.</p> <p>(2) Lug type butterfly valves are available to use the pipe end service on following conditions;</p> <ul style="list-style-type: none"> a) Non-shock water b) Lever or gear operated type (not automatic operated type) c) Maximum pressure; Full working pressure of the valve d) To be locked on full closed position e) Within 4 days (Note1) <p style="padding-left: 40px;">Note1) It is recommended to use the blank flange for long period of time beyond 4days.</p> <p style="text-align: center;">If the valve is used beyond of these conditions, it may cause the external leakage.</p>

 CAUTION	
	<p>(1) Keep the firm footing for valve installation and operation.</p> <p>(2) Prepare sufficient lighting for valve installation and operation.</p> <p>(3) Use supports for firmly holding pipes, if needed to avoid excessive load caused by valve mass or valve operation.</p>
	<p>(4) DO NOT connect the butterfly valve directly with check valve or pumps, which may damage the valve disc by unwanted contact.</p>

- 1.1 Allow sufficient room for operation, installation and subsequent maintenance of valves, considering the valve height and the stem direction.
- 1.2 Take appropriate measures for smooth operation, inspection and maintenance of valves if they are forced to be installed in small spaces.
- 1.3 Try not to install valves in the places where valve functions may be hampered by outer forces such as vibrations.

Valve Installation

2. Care for Piping

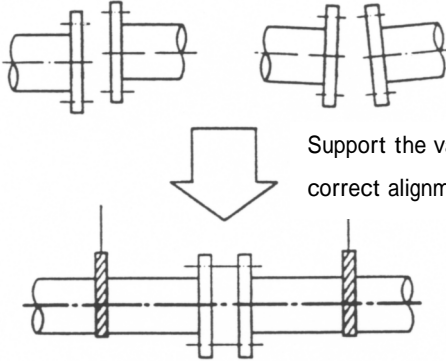
 CAUTION	
	<p>(1) NEVER use the flange gasket for piping, which may cause the leakage.</p> <p>(2) DO NOT forcibly tuck the valve into too narrow space between pipes when piping, which may cause the deformation of the rubber seat and the leakage.</p>
	<p>(3) After flanges are welded with pipes, wait until the welding heat cools down enough before installing the valves.</p> <p>(4) Chamfer or round edge of welded flanges appropriately to prevent the rubber surface from being damaged .</p> <p>(5) Before installation of valves, the connecting pipes should be cleaned to remove any foreign object such as sand, dust or welding spatters.</p> <p>(6) Make sure that the flange surface has no damage and deflection. Remove any foreign object from the flange surfaces. (Make sure that EPDM seats are free from oil.)</p> <p>(7) Align the upstream side and downstream side piping accurately. The leakage from the flange connection will be caused by the inaccurate alignment.</p> <div style="text-align: center;">  <p style="text-align: right;">Support the valve and pipes first for correct alignment.</p> </div> <p>(8) Install or dismantle the valve with the valve open by approx. 10 ° to the full close.</p> <p>(9) Be careful not to apply abnormal force to shaft of manual gear. Deformed shaft causes gear and/or valve failures.</p>

Valve Installation

3 Valve Installation Procedure

3. 1 Set jack bolts to adjust the dimension between pipe flanges, if needed. The dimension between pipe flanges should be 6mm to 10mm wider than face to face dimension of the valve for installation.

3. 2 First, set two bolts into the lower side of the pipe flanges where the lower valve mounting guides make contact with the bolts and mount the valve between the flanges carefully so that the flange faces may not damage or deform rubber seats. Then set two bolts into the upper side of the pipe flanges. DO NOT use flange gaskets, since rubber seats will function as a seal between the flanges and valve body.

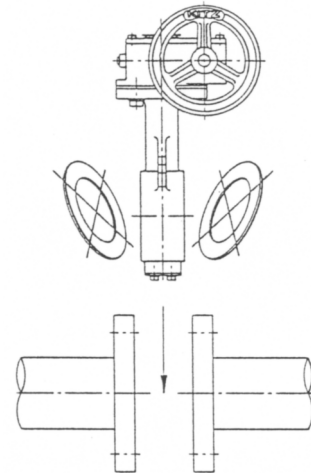

3. 3 Tighten four of the upper and bottom bolts temporarily. Align the pipes and valve accurately.

3. 4 Before tightening piping bolts, make sure that the disc does not get any contacts with the pipe inside in fully open position.

3. 5 Tighten all other bolts through the holes of pipe flanges.

3. 6 Evenly tighten bolts gradually and alternately in a star pattern.

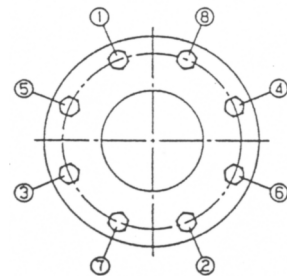

3. 7 Tighten the bolts until the flanges come in contact with the valve body.

Tightening torque is following table.

Bolt size	torque (N · m)
M12	28
M16	67
M20	130
M22	177
M24	226
M27	331
M30	461
M36	804

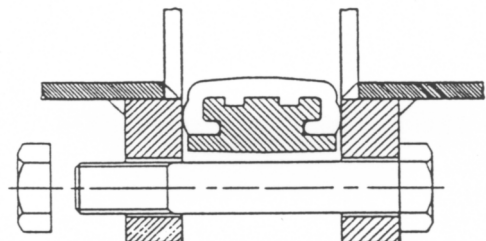

Bolt size	torque (N · m)
5/8	62
3/4	111
7/8	179
1	269
1 1/8	381
1 1/4	538



CHAPTER
Valve Operation

Valve Operation

1. Care for Safety

 CAUTION	
	<p>(1) DO NOT loosen bolts or nuts of flange area on pressuring.</p> <p>(2) DO NOT remove the operator on pressurizing, which makes the stem blow-off from the upper hole.</p> <p>(3) When the pipeline is tested for exceeding the design pressure, do not use the valve as a blank flange by fully closing.</p> <p>(4) DO NOT touch the stopper bolts in the gear operator. It may change the stopper position, which may result in internal leakage.</p>
	<p>(5) When the pipeline is tested for exceeding the design pressure, fully open the valve.</p> <p>(6) To operate the valve, avoid the use of special tools such as pipes or wrenches, which may damage the valves.</p> <p>(7) When the valve is to be used with an opening position less than 30°, contact KITZ or its distributor for technical advises.</p>

2. Valve Operation

2.1 Lever Handle Operation

Turning the lever handle by 90° clockwise will close the valve and rotating the lever counterclockwise will open the valve.

2.2 Worm Gear Operation

According to the letter or arrow on the handwheel, turning the handwheel clockwise will close the valve, and turning the handwheel counterclockwise will open the valve.

Valve Operation

3. Daily Inspection



In order to operate your valves safely and satisfactorily, the daily inspection is very important. Here are the inspection items.

Inspection items	Areas to be inspected	Inspection Method	Remedial measures
External Leakage	Connection area	Visual check Soap water	Retighten piping bolts.
	Body surface	Visual check Soap water	Change the valve.
Abnormal Noises	Valve body	Auditory check	Consult a piping engineer.
	Loosened bolts and nuts	Auditory check	Retighten bolts and nuts.
	Vibration of pipes	Auditory check	Consult a piping engineer
Loosened bolts and nuts	Bolts and nuts	Visual and Tactile check	Retighten bolts and nuts.
Seat leakage			Remove the foreign objects on seat rubber. Disassemble and inspect the valve. (Note1) Change the rubber seat or valve.
Valve operation	Valve position	Visual check	Make sure that the valve is in predetermined open/close position.
	Disturbed operation	Visual and tactile check	Inspect the dismantled valve. Replace the valve.

Note1) The valves with nominal size DN 200 & smaller cannot be disassembled.
Change the valve in this case.

Valve Operation

4. Countermeasures

 CAUTION	
	<p>(1) Wear the protective items such as goggles, gloves, and safety shoes.</p> <p>(2) Take appropriate safety measures for maintenance of valves, which handle toxic, flammable or corrosive fluid.</p> <p>(3) Reduce the line pressure to the atmospheric level before retightening of flange bolts and nuts.</p>

4.1 Leakage from the flange area.

Retighten flange bolts and nuts evenly and alternately in a star pattern.

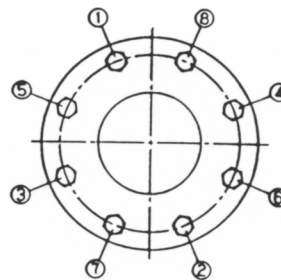
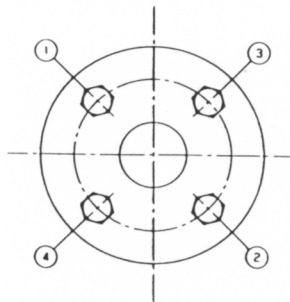

CHAPTER
Periodic Inspection

Periodic Inspection



1. Periodic Inspection
 - 1.1 Carry out periodic inspection about once a year with the valve installed on pipelines.
 - 1.2 Ensure the smooth operation and sufficient valve function to be inspected.
 - 1.3 Refer to Section V "Daily Inspection" for the inspection items to be inspected and inspection methods.
 - 1.4 Carry out the periodic inspection of valves which are not operated for long period or not daily inspected. (Check all valves.)
 - 1.5 It is extremely important to check valves when the valves are used under the following services or conditions:
 - a) Erosion and corrosion of valve interior are expected.
 - b) Choking of fluid is expected.
 - c) The valve is so important for the whole plant operation.



Periodic Inspection

2. Maintenance and Inspection

When piping facilities where the valve is installed are to be set open for periodic maintenance and inspection, carry out the seat and external leakage test and operation test, if needed.

2.1 Care for removal of the valves from pipelines or installation of the valves on pipelines.

 WARNING	
	<ol style="list-style-type: none"> (1) Discharge the fluid from the pipes and reduce the line pressure to the atmospheric level when dismantling the valves from the pipelines. It is dangerous to dismantle valves with the pressure and fluids trapped inside the valves. Possible spout of residual fluids may cause personal injury. (2) Take some measures for maintenance of valves, which handle toxic, flammable, corrosive and explosive fluid. For storage and discard of these valves, they should be handled with appropriate safety measures. Care should be taken to eliminate the possibility for any personnel to contact with such untreated valves. (3) For valves with electric or pneumatic actuators, refer to the operation manuals prepared by the manufactures of the actuators, before handing the valves. (4) Keep off the valve lifting area to prevent damage which may be caused by an extraordinary mechanical impact or load.

 CAUTION	
	<ol style="list-style-type: none"> (1) Wear the protective items such as goggles, gloves and safety shoes. (2) Keep a secure footing for valve dismantle and installation. (3) Use support stands for firmly holding the valve and pipes to prevent misalignment. (4) Before dismantling valves from the pipeline, mark the valve body and coupled pipe flanges with their original position. Reinstall the valve on pipelines according to the marks after reassembly.

2.2 Disassembly and Reassembly

Disassemble and reassemble the valve according the instruction in Section VII of this manual.

For nominal size DN 200 and smaller, valves cannot be disassembled. If any problem is detected, replace the valve for new one.

Periodic Inspection

2.3 Test and Inspection



The following is the main items for test and inspection.

2.3.1 Operation test

- (1) The valve should be operated smoothly by the lever handle or gear operator without galling or sticking.
- (2) The stem should be firmly connected with the disc.
- (3) In fully open position, the disc should be parallel to the fluid flow.

2.3.2 Shell test and seat leakage test

- (1) Care for shell test and seat leakage test

 CAUTION	
	<ol style="list-style-type: none">(1) Wear the protective items such as goggles, gloves and safety shoes.(2) Take some precautions before shell test and seat leakage test for operators' safety.

- (2) Shell test and seat leakage test

All valves should be subjected to a hydrostatic or pneumatic shell test and seat leakage test at the required pressure after tests and inspections.

Refer to the JIS B 2003, EN 12266-1, API 598 or MSS SP-61 for test methods.



CHAPTER



Disassembly and Reassembly of Valves

Disassembly and Reassembly of Valves

1. Disassembly

1.1 Care for Safety

 WARNING	
	<p>(1) Operator should take an appropriate caution for not being exposed to the fluid or not to catch fire.</p> <p>(2) Take attention to blow out the stem and bottom stem when disassembly the valve. Because line pressure may come into the stem hole on the disc during in service.</p>

 CAUTION	
	<p>(1) Wear the protective items such as goggles, gloves and safety shoes.</p> <p>(2) Take care not to catch fingers during disassembly.</p> <p>(3) When disassembling valves of big mass one, use an appropriate lifting machine for safety operation.</p>

1.2 Before Disassembly

1.2.1 Place the valve in a dust-free area.

1.2.2 Take care not to damage the sealing surfaces such as disc seat surface and seat rubber.

Disassembly and Reassembly of Valves

1.3 Disassembly Procedure (DN 50 to DN 200)

1.3.1 These valves cannot disassembly because the rubber seat (106) is vulcanized to the body (1) and the stem (3) is pressed into the disc (4).

1.3.2 If any damage is detected on the valve components, replace the valve for new one.

1.4 Disassembly Procedure (DN250 & DN 300 with vulcanized rubber seat construction)

1.4.1 Give adequate match marks on edges of the actuators (gear, pneumatic or electrical valve actuator) and the body (1) for right and easy reassembly. Remove the actuators from the body (1) by removing the bolting.

1.4.2 Remove the end plate bolts (35), and remove the end plate (147) from the body (1).

1.4.3 Remove the gland plate bolts (36) and remove the gland plate (144) from the body (1), then pull out the stem (3) from the body (1) by making use of the tapped hole on the top of the stem (3). (Refer to FIG. Right)

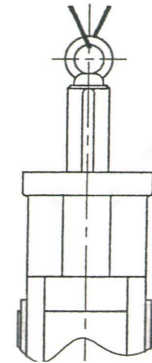

1.4.4 Insert the rod, whose diameter is smaller than that of the stem, from the top hole of the body (1), and hammer it lightly to remove the bottom stem (103).

1.4.5 Fully open the valve, and remove the disc (4) from the body (1) taking care not to damage the edge of the disc.

1.4.6 The rubber seat (106) is vulcanized to the body (1), so it cannot be disassembled.

1.4.7 Remove the bearings (67A, B and C) and O-rings (45A and B) from the stem (3) and bottom stem (103).

Disassembly and Reassembly of Valves

1.5 Disassembly Procedure (DN 250 to DN 600 with built-in rubber seat construction)

1.5.1 Give adequate match marks on edges of the operators (gear, pneumatic or electrical valve actuator) and the body (1) for right and easy reassembly. Remove the operators from the body (1) by removing the bolting.

1.5.2 Remove the end plate bolts (35), and remove the end plate (147) from the body (1).

1.5.3 Remove the gland plate bolts (36) and remove the gland plate (144) from the body (1), then pull out the stem (3) from the body (1) by making use of the tapped hole on the top of the stem (3). (Refer to FIG. Right)

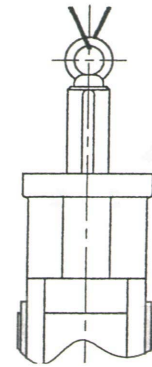

1.5.4 Insert the rod, whose diameter is smaller than that of the stem, from the top hole of the body (1), and hammer it lightly to remove the bottom stem (103).

1.5.5 Fully open the valve, and remove the disc (4) from the body (1) taking care not to damage the edge of the disc.

1.5.6 Remove the rubber seat (106) by inserting a flat blade screwdriver between the body (1) and the rubber seat (106) to make the space and putting the hand into that space to pull the rubber seat out. (Refer to FIG. Right)

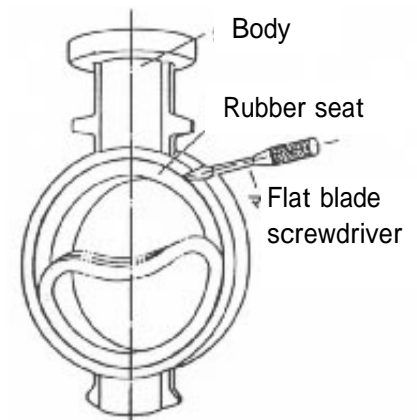



1.5.7 Remove the bearings (67A, 67B and 67C) and O-rings (45A and 45B) from the stem (3) and bottom stem (103).

Disassembly and Reassembly of Valves

2 Reassembly

2.1 Care for safety

 CAUTION	
	<ul style="list-style-type: none">(1) Wear the protective items such as goggles, gloves and safety shoes.(2) Take care not to catch fire during reassembly.(3) Take care not to catch, fingers during reassembly.(4) O-rings and bearing shall be used new one. The reuse of o-rings may cause leakage.(5) When reassembling valves of big mass one, use appropriate lifting machine for safety operation.

2.2 Before Reassembly

2.2.1 Check all necessary parts before reassembly. If the valve is found dissatisfactory in its function, replace the valve.

2.2.2 In case the parts are reused, ensure to clean the parts to completely remove the oil, dust and other foreign objects.

2.2.3 Reassemble the valve at a dust-free place.

2.2.4 Take care not to damage the seating area of the disc and rubber seat.

Disassembly and Reassembly of Valves

2.3 Reassembly Procedure (DN 250 & DN 300 with vulcanized rubber seat construction)

- 2.3.1 Install the bearings (67A, 67B and 67C) and O-rings (45A and 45B) on the stem (3) and bottom stem (103)
- 2.3.2 Press the disc (4) into the body (1) with fully open position. Take care not to damage the disc edge. Apply a little grease (Note1) to the top and bottom of the disc (4) and the rubber seat (106) and its sealing area for easy works. Make sure that the holes of the body (1) are correctly aligned with those of the disc by looking from the body top and bottom. (Before reassembly, make sure for the correct direction of the stem and disc.)
- 2.3.3 Insert the bottom stem (103) into the body (1) with the wooden hammer. Apply grease (Note2) lightly to the bottom stem (103).
- 2.3.4 Insert the stem (3) into the body (1) with the wooden hammer matching the hole configuration (square or key groove) of the disc (4). Apply grease (Note2) lightly to the stem (3).
- 2.3.5 Install the gland plate (144) on the body (1).
- 2.3.6 Install the end plate (147) to the body (1).
- 2.3.7 Adjust the disc (4) and the valve actuator to appropriate open/close position. Install the actuator with applicable bolting. Make match the marks provided before disassembly.

(Note1) Silicon grease, SHINETSU CHEMICAL, "KF - 96 - 100000 cSt" or higher grade is recommended.

(Note2) SUMICO LUBRICANT, "Moly Rubber Grease No.1" is recommended.

Disassembly and Reassembly of Valves

2.4 Reassembly Procedure (DN 250 to DN 600 with built-in rubber seat construction)

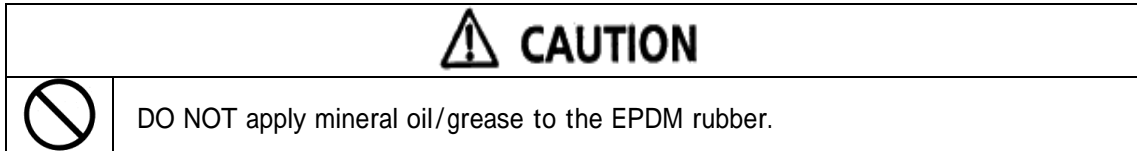

- 2.4.1 Install the bearings (67A, 67B and 67C) and O-rings (45A and 45B) on the stem (3) and bottom stem (103).
- 2.4.2 Place the body (1) upside down. Press down the rubber seat (106) and insert it into the body. Match the groove of the body with the projection of the rubber seat.
- 2.4.3 After insertion, align the holes of the rubber seat (106) with those of both side of the body (1).
- 2.4.4 Apply some greases to the stem hole of the rubber seat (106) for easy works. (Note1)
- 2.4.5 Press the disc (4) into the body (1) with fully open position. Take care not to damage the disc edge. Apply a little grease (Note1) to the top and bottom of the disc (4), and the rubber seat (106), and its sealing area for easy works. Make sure that the holes of the body are correctly aligned with those of the disc by looking from the body top and bottom. (Before reassembly, make sure for the correct direction of the stem and disc.)
- 2.4.6 Insert the bottom stem (103) into the body (1) with the wooden hammer. Apply grease (Note2) lightly to the stem.
- 2.4.7 Insert the stem (3) with the wooden hammer into the body (1) matching the hole configuration (key way groove) of the disc (4). Apply grease (Note2) lightly to the stem.
- 2.4.8 Install the gland plate (144) to the body (1).
- 2.4.9 Install the end plate (147) to the body (1).
- 2.4.10 Adjust the support bolt (A) to position the disc (4) in the center of the rubber seat (106). Fix the support bolt (A) with the hexagon nut (13) after adjusting properly.
- 2.4.11 Adjust the disc (4) and the valve actuator to appropriate open/close position. Install the actuator with applicable bolting. Make match the marks provided before disassembly.

(Note1) Silicon grease, SHINETSU CHEMICAL, "KF - 96 - 100000 cSt" or higher grade is recommended.

(Note2) SUMICO LUBRICANT, "Moly Rubber Grease No.1" is recommended.

Disassembly and Reassembly of Valves

3. Exploded View Drawing. (DN 250 & DN 300)

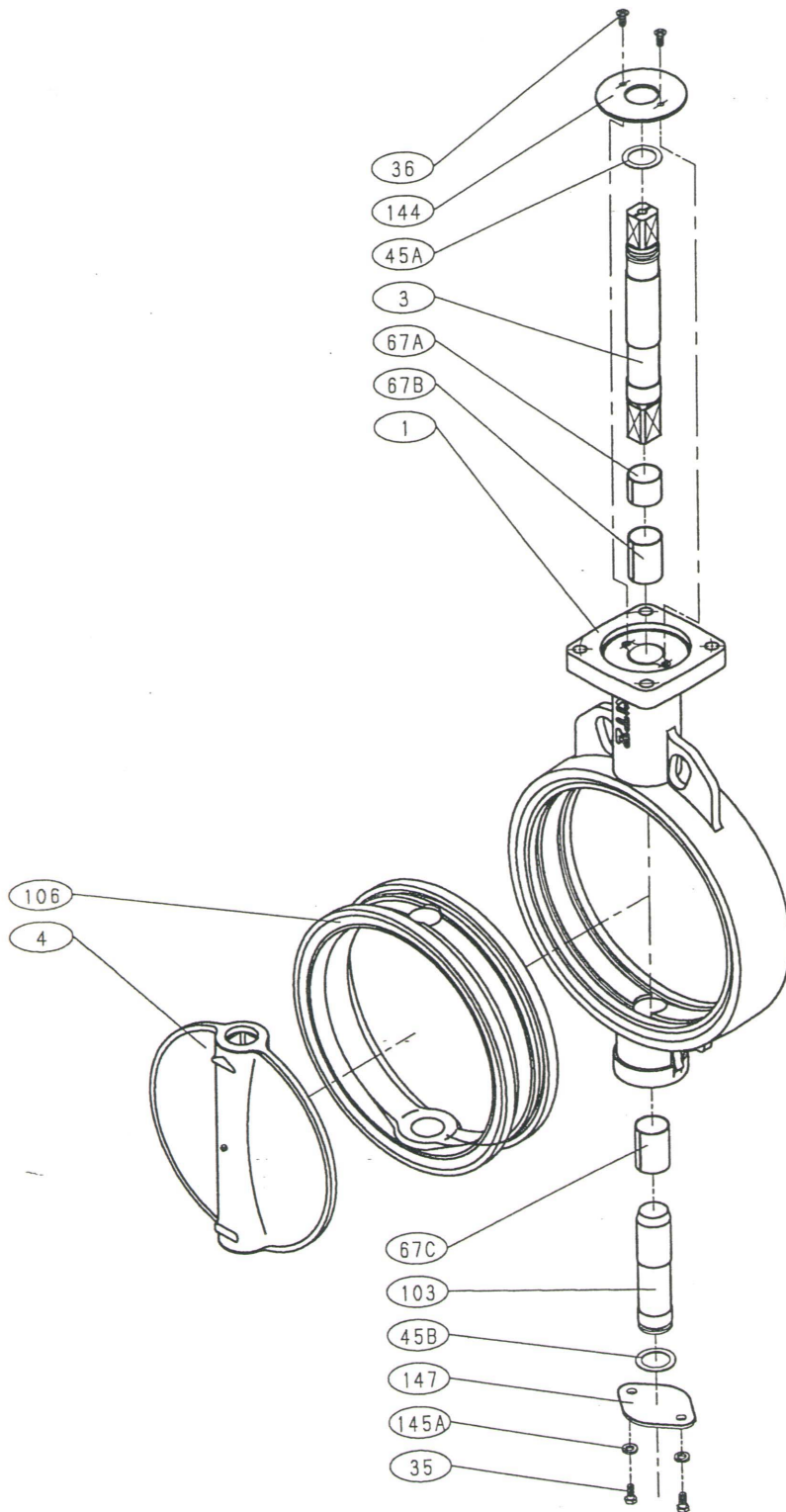

No.	Parts Name
1	Body
3	Stem
4	Disc
35	Hexagon bolt
36	Bolt
45A	O ring
45B	O ring
67A	Bearing
67B	Bearing
67C	Bearing
103	Bottom stem
106	Rubber seat
144	Gland plate
145A	Spring washer
147	End plate

This drawing indicates a typical construction of the valve.
 Refer to the approval drawing before disassembly and assembly.

Disassembly and Reassembly of Valves

4. Exploded View Drawing. (DN 350 to DN 600)

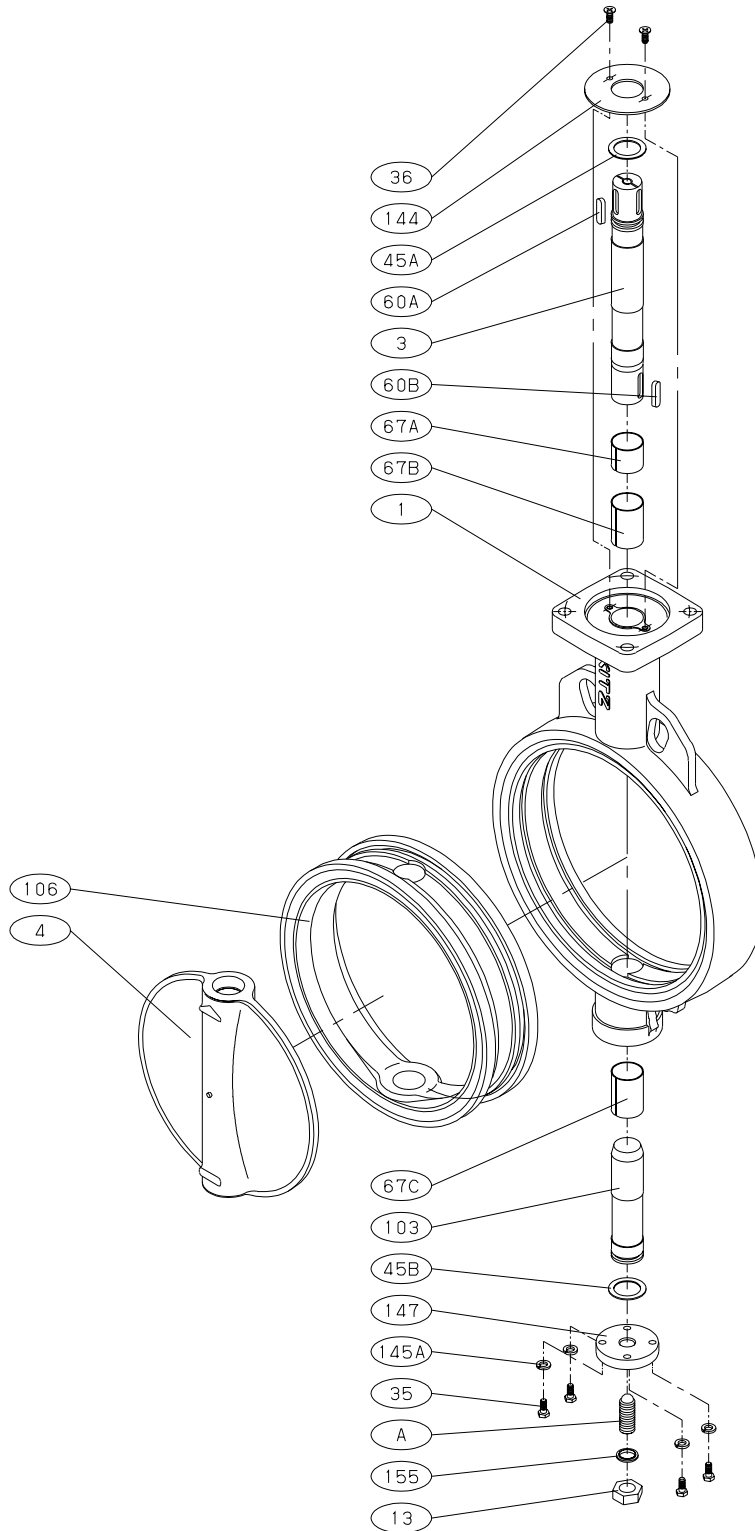

No.	Parts Name
1	Body
3	Stem
4	Disc
13	Hexagon nut
35	Hexagon bolt
36	Bolt
45A	O ring
45B	O ring
60A	Key
60B	Key
67A	Bearing
67B	Bearing
67C	Bearing
103	Bottom stem
106	Rubber seat
144	Gland plate
145A	Spring washer
147	End plate
155	Seal washer
A	Support bolt

This drawing introduces a typical construction of the valve.
Refer to the approval drawing before disassembly and assembly.